

396-3624Y1



Fertigation and Chemigation Injection Manual

DC Pump Models



Table Of Contents

Introduction

- Safety
- Warranty Policy
- Marksman System Example Layout

Components - Liquid

- Parts List
- Marksman Plumbing Accessories

Components - Wiring & Electrical

- Power Supply Kit Options
- Marksman Wiring Harness Schematic
- Marksman Harness Accessories

Controller Setup & Operation

- Controller Keys and Menu Structure
- Front Screen and Main Menus
- Advanced Menus

Troubleshooting

- Marksman Error Messages
- Flowmeter Calibration Process
- Electric Pump Driver (EPD) error codes

Maintenance & Parts

- Winterization

A

B

Components
Liquid

D

Components
Wiring & Elec.

F

Setup &
Operation

G

Trouble-
Shooting

H

Maintenance



Safety

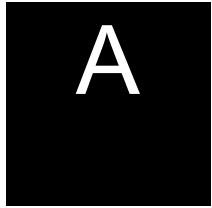

TAKE NOTE! THIS SAFETY ALERT SYMBOL FOUND THROUGHOUT THIS MANUAL IS USED TO CALL YOUR ATTENTION TO INSTRUCTIONS INVOLVING YOUR PERSONAL SAFETY AND THE SAFETY OF OTHERS. FAILURE TO FOLLOW THESE INSTRUCTIONS CAN RESULT IN INJURY OR DEATH.



**THIS SYMBOL MEANS
ATTENTION!
BECOME ALERT!
YOUR SAFETY IS INVOLVED!**

Note the use of the signal words DANGER, WARNING and CAUTION with the safety messages. The appropriate signal word for each has been selected using the following guidelines:



DANGER: Indicates an imminently hazardous situation that, if not avoided, will result in death or serious injury. This signal word is to be limited to the most extreme situations typically for machine components which, for functional purposes, cannot be guarded.



WARNING: Indicates a potentially hazardous situation that, if not avoided, could result in death or serious injury, and includes hazards that are exposed when guards are removed. It may also be used to alert against unsafe practices.



CAUTION: Indicates a potentially hazardous situation that, if not avoided, may result in minor or moderate injury. It may also be used to alert against unsafe practices.

NOTICE is used to address safety practices not related to personal safety.



Warranty Policy

A

SurePoint Ag Systems, Inc. (hereinafter referred to as "SurePoint") warrants the whole goods products it sells to be free from defects in material or workmanship for a period of one (1) year from the date of sale of the product(s) to the original user.

SurePoint warrants the parts it sells to be free from defects in material or workmanship for a period of ninety (90) days from the date of delivery of the product(s) to the original user. This shall include replacement parts installed by SureFire.

Warranty of SurePoint whole goods and/or parts applies only to material and workmanship. Misuse, misapplication, neglect, alteration, accident, normal wear, or acts of God affecting SurePoint products are not eligible for warranty. Warranty shall apply only to the smallest reasonably serviced component (e.g. if a PWM solenoid fails on a hydraulic pump assembly, only the solenoid will be covered under warranty, not the entire pump assembly). In the event that multiple components are replaced, component warranty eligibility will be assessed once the parts are returned to SureFire for determination of failure (parts determined to still be in working order will be returned to the dealer and warranty will not apply to those components).

WARRANTY CLAIMS: A warranty claim and request to return defective product(s) must be presented to the SurePoint Service Department, describing the defect in material or workmanship of the product(s). This claim may be made via phone, e-mail, fax, or written request. Claims for warranty of whole goods or parts must also include proof of date of sale of the product(s) to the original user.

The SurePoint Service Department will proceed in making a preliminary decision as to the eligibility of the claim for warranty consideration. After the SurePoint Service Department deems it necessary to proceed with warranty consideration, a determination will be made as to whether or not the original product needs to be returned to SurePoint. In the event a return is deemed necessary, a Return Materials Authorization (RMA) will be generated by the SurePoint Service Department. The defective product(s) in question must be sent, freight prepaid, within fourteen (14) days of the discovery of the product failure and initial warranty claim. Replacement product(s) may be sent to the selling dealer, directly to the customer, or picked up at the SureFire facility. At the discretion of the SurePoint Service Department, replacement product(s) may be sent prior to, or after, the SurePoint Returns Department receives the defective product(s).

Any variation in the above procedure is at the sole discretion of the SurePoint Service Department.

SurePoint agrees to handle all warranty claims in a timely manner and will inform dealers of any revisions or modifications to the SurePoint Warranty Policy. Eligible warranty claims will be processed by SureFire within sixty (60) days of receiving failed product (s).

If a warranty claim is found to be ineligible for warranty coverage, the SurePoint Service Department will be responsible to inform the dealer or end user in order to determine the course of action to be taken. SurePoint reserves the right to make changes in specification and design without notice and without incurring any obligations to owners of products previously sold.



Typical Marksman Setup

B

Components
Liquid



This picture shows Marksman installed on a 2,000 gallon nurse trailer to be pulled to multiple irrigation sites. Marksman can be installed in a mobile manner or can be installed at a single irrigation site for season-long use.



This Marksman is powered with 480 VAC 3-Phase power present at the irrigation site.



The Marksman output hose is attached to the injection quill mounted in the irrigation system water one way valve assembly. A bleeder valve is mounted with the injection quill to let air out of the system. The water pressure sensor is used to shut down the Marksman if irrigation water pressure is lost.



Parts List

B

Components

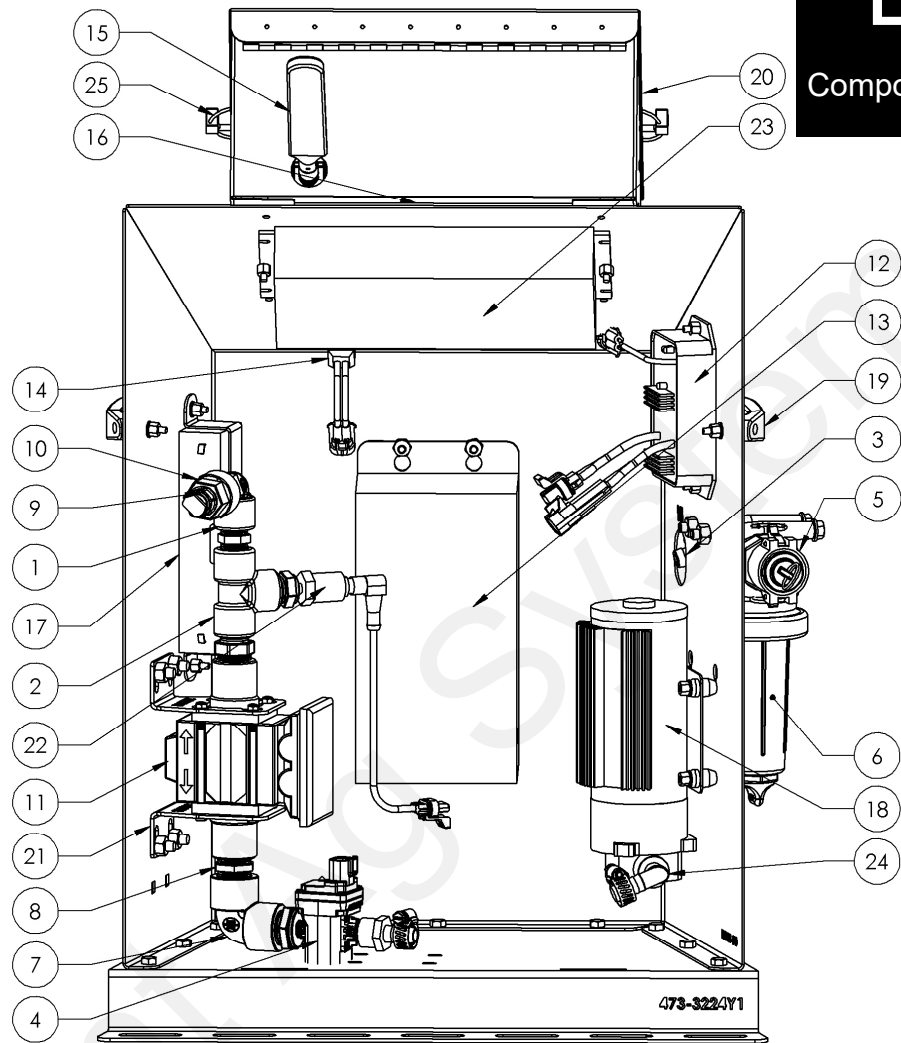

Marksman Low Pressure Pump Specifications

Minimum Flow:	6 GPH
Maximum Flow:	60 GPH
Maximum Operating Pressure:	50 PSI

ITEM	PART NUMBER	DESCRIPTION
1	100-050050SL-90	1/2" Street Elbow - 90 Degree
2	100-050TEE	1/2" TEE
3	101-075050-90	3/4" MPT x 1/2" HB - 90 Degree
4	103-3841Y1	Zip Valve 1/4" MPT Kynar, 2-Way, Stainless Steel Ball, Deutsch Connector
5	106-075B	3/4" Female Coupler x 3/4" MPT
6	109-075LST-50V	3/4" Tee Strainer -Viton - 50 Mesh
6a	110- LST150	LST 50 Mesh Screen (other screen sizes available)
7	100-050EL-90	1/2" Pipe Elbow
8	100-050NIP-SH	1/2" Short Nipple
9	113-06-0038050-P	QC to MPT - 3/8" QC x 1/2" MPT
10	136-5492K999	1/2" Polypropylene Check Valve with Viton Seals and Stainless Steel spring
11	204-01-4112Y1	Polypropylene Electro Magnetic Flow meter 0.08 - 3.0 GPM Non-visual
12	205-18385	PWM Electric Pump Driver (EPD) with MP480 Connectors
13	208-08-3246Y1	480V to 110V 600VA Transformer and Harness
14	217-3466Y1	Sealed Toggle Switch for Outdoor Mounting with 2 Pin MP150 Shroud Connector
15	217-3650Y1	Marksman Controller Antenna
16	224-3561Y1	Marksman Controller Assembly - With Modem (224-3560Y1 No Modem)
17	261-BP2.3-12	Marksman Battery Lead Acid 12V 2.3AH
18	290-01-3253Y1	3 Chamber Electric Diaphragm Pump with cooling fins (2.0 GPM Open Flow)
19	399-1950A3	Black Handle with Gray Dots
20	473-3823Y1-SS	Hinged Controller Shield - Stainless Steel
21	400-3826Y1-SS	SS Flowmeter Mounting Bracket
22	521-05-050400	400 PSI 3 wire pressure sensor (0-5 VDC) with 3-pin 150 MP Tower Connector
22	546-02-100300	120VAC to 15 VDC Power Supply (Kit contains 209-3142Y1 and hardware)
23	708-20381-024	Flow Jet Oring Quick Connect x 3/8" and 1/2" HB - 90 Degree
24	355-030109-WC	Lynch Pin - 3/16" x 1 - 9/16" with chain

Marksman Plumbing Accessory Items

B

Components

Marksman Inlet Plumbing Kit

546-05-100100



106-200D
2" Cam x 2" MPT



100-200075RB
2" x 3/4" Bushing



101-075075-H
3/4" MPT x HB



280-075-AG200
3/4" Hose (25 ft)



106-075E
3/4" HB x Cam

The inlet plumbing kit includes the items shown above along with hose clamps and thread sealer. It will connect a 2" male camlock to the marksman inlet (3/4" female cam lock on Marksman strainer). 3/4" hose maximum 20 feet long can be used for flows up to 180 GPH. Over this length and flow rate use a larger diameter inlet hose.

Marksman Outlet Plumbing Kit

546-05-100150



113-01-038050



280-050-AG200



113-01-038050



101-050050-H



100-075050RB

The Marksman outlet plumbing kit has a 3/8" stem fitting to connect to the Marksman outlet quick connect fitting. The kit contains 20' of 1/2" hose and either 3/8" stem or 1/2" MPT fitting to attach to your injection point.

The 3/8" stem x 1/2" hose barb fitting is also included with every Marksman to attach to an existing 1/2' hose.

What size Marksman outlet hose do I need?

There is no one size fits all answer to this question. However, the safe answer is a larger hose won't cause you any problems. **A 50 foot long 1/2" hose can be used at flow rates up to 180 GPH with a product no higher viscosity than 28% or 32% nitrogen.** This will have a pressure drop of 10 psi in the hose which is the maximum pressure drop SureFire recommends. If you are over this hose length, flow rate or viscosity use a larger hose; consult SureFire for recommendations.

3/8" tubing (1/4" ID) is a convenient choice and will work for lower flow rates. **A 15' foot length of 3/8" tubing can be used at flow rates up to 40 GPH with a product no thicker than 28% or 32% nitrogen.** If you are over that hose length, flow rate or viscosity use the 1/2" hose outlet plumbing kit above.

Marksman 480 VAC to 120 VAC Transformer

D
Components
Wiring &
Electric



DANGER

Transformer assembly maintenance needs to be performed by a qualified electrician. Electrical shock will cause severe injury or death.

The 12 VDC Pump Marksman can be powered from 480 VAC 3-phase, 120 VAC single phase or directly from 12 VDC power. If powered from 480 VAC 3-phase the transformer is used to convert 480 VAC to 120 VAC.

DANGER

High voltage.
Disconnect power before servicing.

Wiring Instructions for cord furnished:
Green - Ground
Black #1 - Line 1
Black #2 - Line 2
 Line 1 to Line 2 must measure 480 V. Line 1 and Line 2 can be any 2 phases of a 3-phase power source.

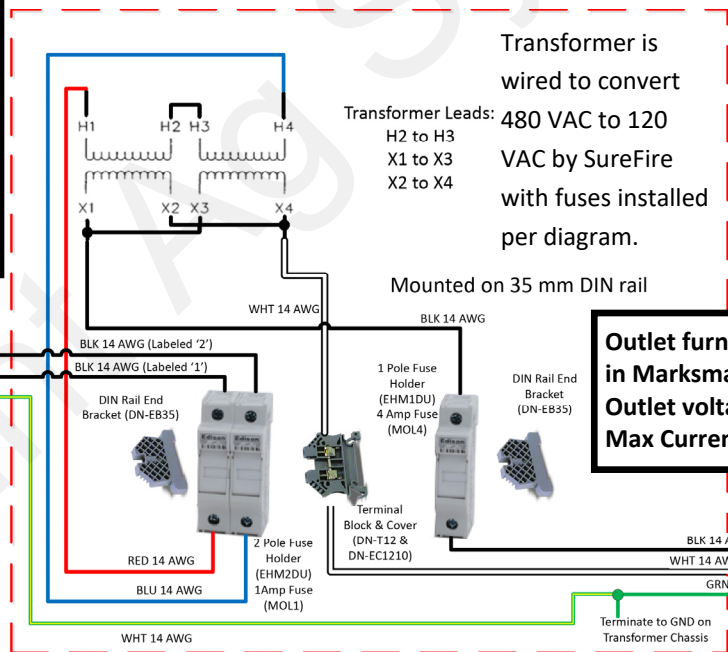

Outlet furnished to plug in Marksman:
Outlet voltage: 120 VAC
Max Current: 4 amps

Power Kits

Marksman is available with 3 power supply kits depending on your available power at the irrigation site. The Marksman components are all 12-15 volt DC, so whatever power source you have available will be converted to 12-15 volt DC.

12 Volt DC Direct **546-02-100100**

The 12 volt direct kit simply consists of a 15' harness with ring terminals to attach to your engine battery. The harness has a MP480 connector to plug into the Marksman. If you need more than 15' of harness order MP480 extensions as necessary.

110 Volt AC **546-02-100200**

The 110 volt power option uses an AC to DC power supply. The power supply used is a 15 volt power supply. Marksman has a 15 volt power supply to supply voltage equal to or slightly greater than vehicle electrical systems to get maximum pump output.

480 Volt AC 3-Phase **546-02-100300**

The 480VAC option uses a transformer to convert 480 VAC down to 110 VAC and then the same power supply to convert 110 VAC to 15VDC. The 480 VAC power kit includes both the transformer and the power supply. The 480 VAC transformer comes with a bare wire cord for the customer to wire directly or attach a plug to for 480 VAC. It has 2 black wires to attach to any 2 phases of 480 VAC 3-phase and a green wire for ground.



Marksman 12 VDC Control Harness

208-08-3527Y1

D

Components
Wiring &
Electric

SurePoint Ag Systems

Marksman Accessory Items

Marksman Aux Function Adapter Harness

208-08-3548Y1

The Marksman aux adapter harness is required if you will connect a water pressure sensor or water flow meter. This adapter harness plugs into the 6-pin Aux connector on the Marksman control harness.

The Aux Pressure and Float connectors are for future Marksman features and are not functional as of mid-2017.

Water Flow Meter Compatibility

Marksman should be compatible with any water flow meter that produces a square wave output signal. Contact SurePoint about specific flowmeter compatibility and extension harnesses for your meter. With a water flow meter Marksman will:

- Vary fertilizer or chemical flow proportionally to water flow. This will allow you to apply the correct rate of product in a corner swing arm system or any system where water flow and irrigated area vary.
- Send water flow reading to Marksman website for remote monitoring.

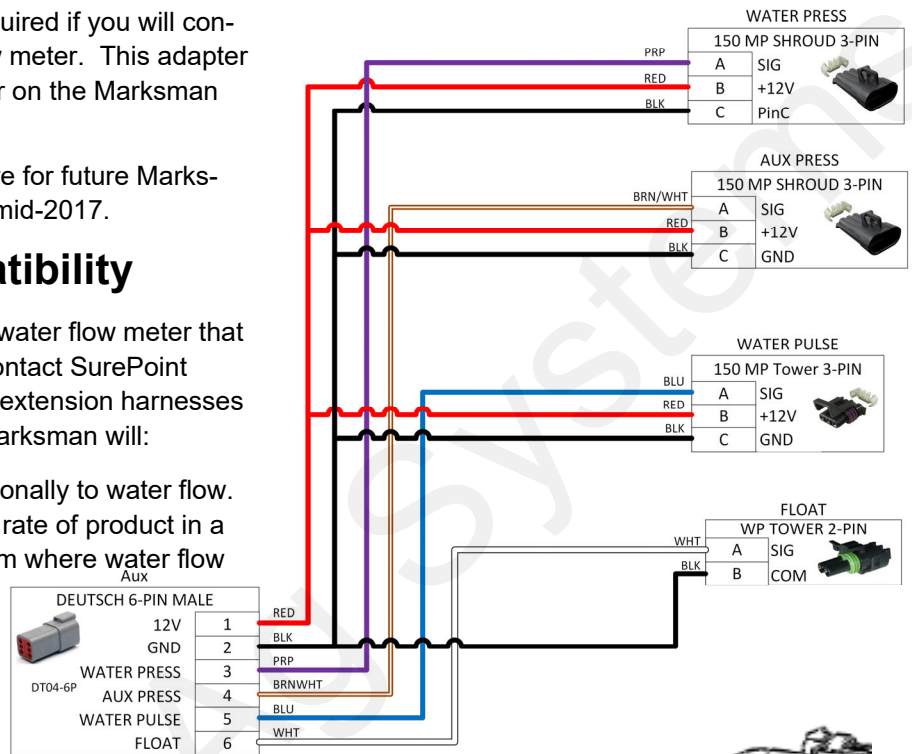

0-400 PSI Pressure Sensor Kit for Marksman

521-05-050400

Use this pressure sensor if you want to connect your Marksman to digitally read water pressure. It includes the sensor w/ 1/4" MPT connection and 2' connector harness. It is the same sensor used on the Marksman for chemical pressure too. With a water pressure sensor your Marksman will:

- Shut down if water pressure is too low (one method to shut off Marksman if irrigation system shuts down). User must set low pressure setting.
- Shut down if water pressure is too high. User must set high pressure setting.
- Send water pressure reading to Marksman website for remote monitoring

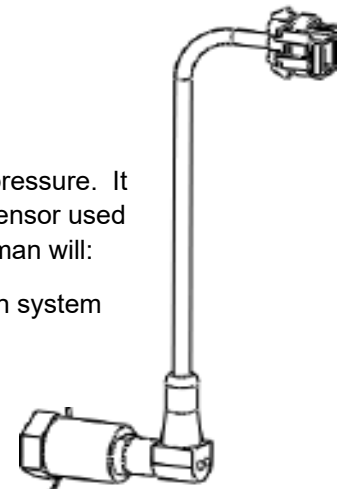

3 Pin Metripack 150 Extensions for pressure sensors

You will most likely need an extension harness to connect the water pressure sensor to the Marksman (the included harness is only 2' long). Choose the length to reach from the Marksman to the pressure sensor location.

5 feet	206-03-13205
10 feet	206-03-13206
15 feet	206-03-13207
20 feet	206-03-13208
25 feet	206-03-13209
50 feet	206-03-13419

Marksman Accessory Items

Marksman Third Party Compatibility Adapter Harness

208-08-3534Y1

The third party compatibility harness is designed to allow Marksman to communicate with the AgSense CropLink. With a connection to CropLink you can use AgSense to:

- Monitor Chemical Pressure
- Monitor Chemical Flow
- Monitor Water Pressure
- Monitor Water Flow
- Command Marksman Rate for variable rate application

Third Party Adapter	
DEUTSCH 8-PIN FEMALE	
RED	1 12V
BLK	2 GND
BLU/WHT	3 CHEM PULSE
BLU	4 WATER PULSE
PRP/WHT	5 CHEM PRESS
PRP	6 WATER PRESS
ORG	7 0-10V SETPOINT
	8



Marksman also provides power to the CropLink box (red and black wires) so no other power source is required for CropLink.

Route the 7 wires on harness 208-08-3534Y1 through a grommet in the bottom of the CropLink box. Attach to terminal blocks as shown in the diagram at right. Plug the 8-pin connector into the Marksman harness connector labeled "Third Party Interface".

The harness is 8 feet long so no extension is required in many cases. If mounting CropLink over 8' from the Marksman order the correct 8-pin extension.

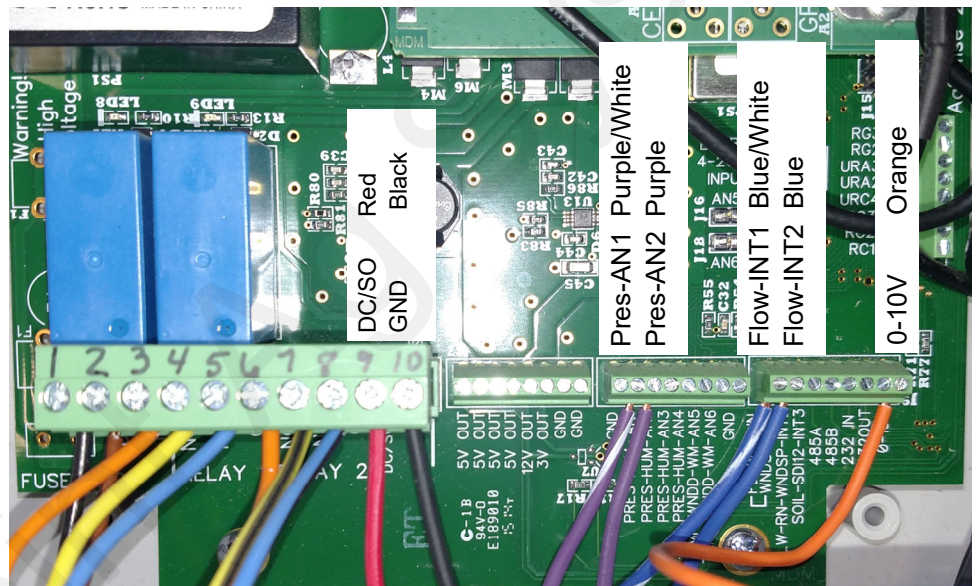

KEYS

Marksman



- Power ○
- WFlow ○
- CFlow ○
- Status ○

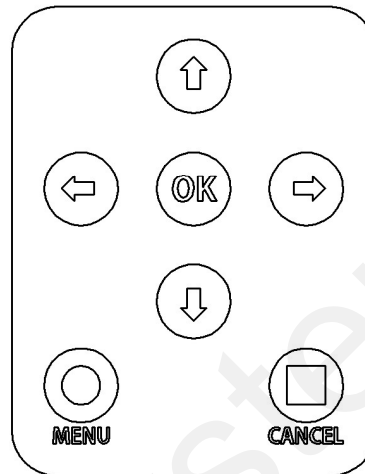
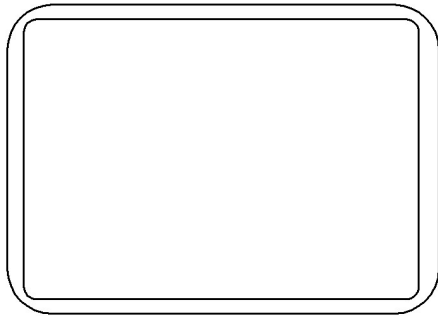

The Injection Controller is controlled by 7 keys on the front panel.

MENU

The menu key is used to enter the advanced menus. Press and hold MENU for 3 seconds to enter the advanced menus. Press MENU again to exit any menu and return to the home screen.

CANCEL

The cancel key will stop the pump, exit any menu and return you to the front screen. On the Diagnostic 1 and 2 screen CANCEL will stop the pump and not return you to the home screen so you can continue any troubleshooting activity.

OK

The OK button will start the pump when on the front screen. In the menu screens, the OK key will enter and exit programming fields. The OK button will also start the pump on the Diagnostic 1 screen for troubleshooting in the advanced menus.

ARROW KEYS

The **up and down arrow keys** are used to navigate up and down the menu pages. After selecting a menu item, the up and down keys are used to increase or decrease the value. If the value is a list of choices, the up and down keys will scroll through the available choices.

The **left and right arrow keys** are used to select which digit to change when changing a number in the menus. Also, the left and right keys will let you move between menu pages forward or backward one page.

MENU STRUCTURE

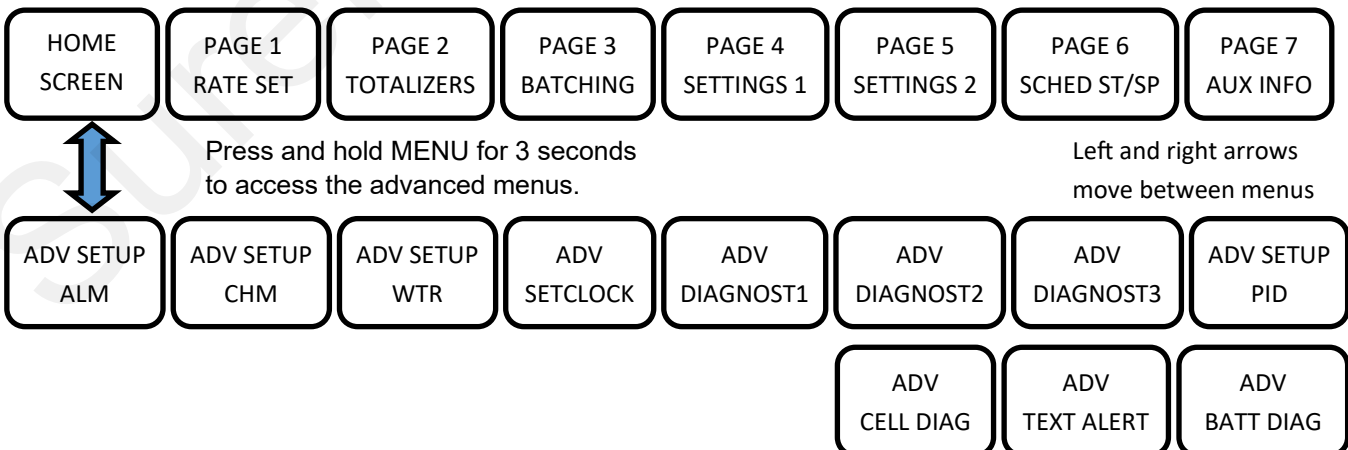

* After 5 minutes of inactivity, the controller will exit advanced menus and return to the home screen

HOME SCREEN

F

Setup &
Operation

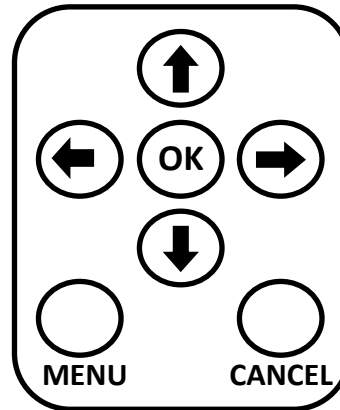
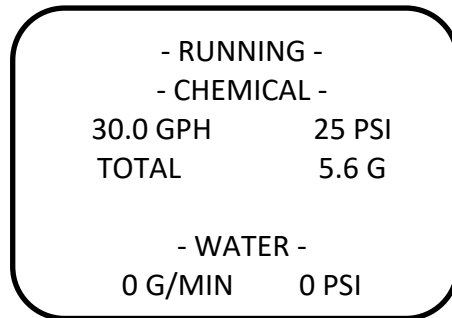

The main screen of the injection controller is shown above. This screen communicates the current status and operation of the unit.

STATUS LINE

The top line currently shows RUNNING, which is the status when pumping. When the pump is stopped (and not in an alarm condition) the status will show STOPPED. If a start delay is used, DELAYED START will be displayed with seconds remaining. When a scheduled start or stop is active, it will periodically flash SCHED STRT&STP. If calculated tank alarm is used and is below the set alarm value, LOW TANK LEVEL will periodically flash. In the event that batch irrigation kill delay is being used, IRRIG KILL DELAY will be displayed along with minutes remaining. If an alarm event occurs, the top line will show the error message. See section G for a full list of error messages and troubleshooting steps for each.

CHEMICAL (FERTILIZER) STATUS

This section will indicate the current operation of the injection unit. The screen above is showing a current injection rate of 30.0 GPH (gallons per hour). This may be displayed in other units which are set on RATE SET screen. The screen above shows 25 PSI from the pressure sensor.

The TOTAL line shows the amount dispensed in the current batch. TOTAL (BATCH TOTAL) resets in two ways.

- If using the batch function (BATCHING) the TOTAL counts up until the batch amount is reached and then injection automatically stops. TOTAL will continue to show the batch total after product stops dispensing. When OK is pressed again, the batch will automatically reset to 0.0 and another batch will be dispensed.
- The TOTAL may also be manually reset on BATCHING screen.

If the batch function is enabled a SPT line will appear below TOTAL. This will display the setpoint for the batch. This line will be blank when batching is disabled.

WATER STATUS

This section will indicate the current water flow and pressure in the irrigation system if water flowmeter and/or pressure transducer are connected. The water flow will display in G/MIN and the pressure in PSI.

REMOTE RATE

If remote setpoint is enabled (SETTINGS 1), water status will be replaced by the current target commanded by the remote device.

MENU 1/7 RATE SET

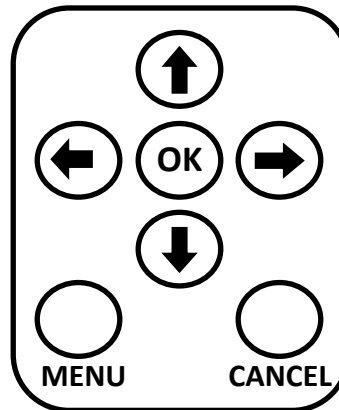
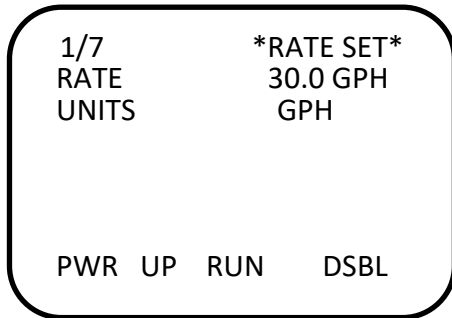

From the HOME screen, press right arrow once to access this page.

RATE

Set the desired application rate. The units shown above are GPH (gallons per hour). Change the units before setting the application rate.

UNITS

This sets the units the application rate will be set and measured in. This can not be changed while running.

ML/M Milliliters per minute (see box to right)

GPH Gallons per hour

OZ/M Ounces per minute

GPM Gallons per minute

G/AC Gallons per acre—for use with center pivots, requires setting pivot length and speed on menu 5/7

OZ/AC Ounces per acre—for use with center pivots, requires setting pivot length and speed on menu 5/7

Milliliters / Minute Operation

1. Set the UNITS to ML/M
2. The calibration number will automatically be converted to pulses / liter and totals will be converted to liters once this screen is exited; it will show PULSES/L on ADV SETUP CHM page and totals in L. For the default 22710 PULSES/G, it will convert to 6000 PULSES/L.
Conversion: $22710 \div 3.78 \text{ L/gal} = 6000$

POWER UP RUN

With this mode turned on (ENBL—enable), the pump will immediately begin running when the power is turned on. If used in conjunction with Batch mode enabled, the controller will dispense the batch amount every time the power is turned on. If it didn't complete the batch before it was turned off, it will complete the batch instead of starting over.

RATE / ACRE

When rate is in Unit / AC, and extra line with Unit / minute shows up. Pivot length and speed settings must be correct on menu page 5/7 this value to be accurate.

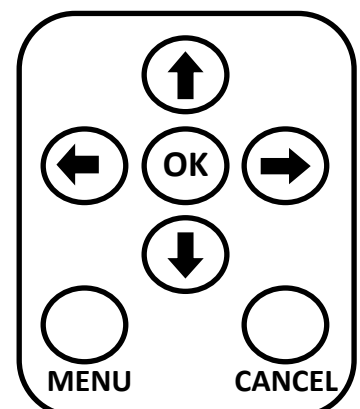
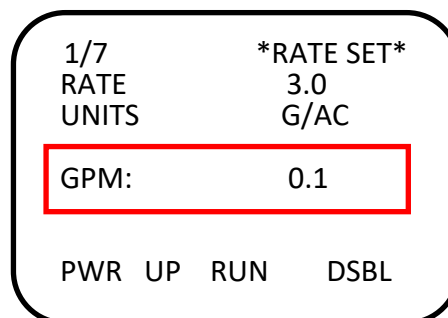

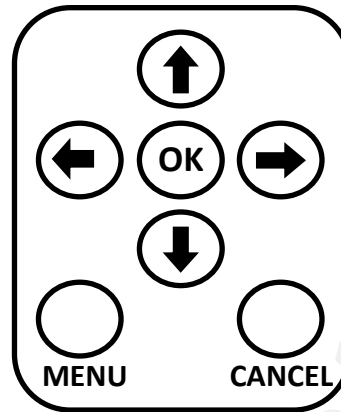
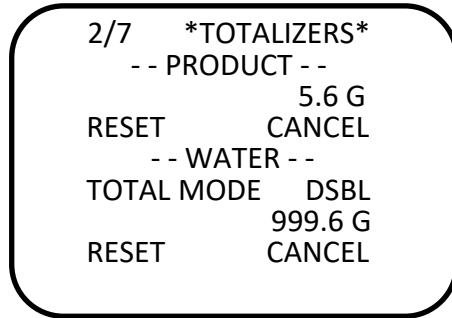

PRODUCT TOTALIZER

The Product totalizer can be used for measuring any total the user desires (total on a field, total dispensed out of a tank, etc.). The Product totalizer is only reset by choosing reset on this page (or the website if applicable). The Product totalizer is saved to memory and will not reset on power down.

If using the mL/M (Milliliters per minute) units the batch total will be set in Liters.

The Product totalizer will rollover back to zero at 100,000,000 (Gallons or Liters)

PRODUCT TOTALS IN METRIC UNITS

If using the mL/M (Milliliters per minute) units the user and batch total will be in liters. If you switch to mL/M units, the current total will be converted to liters. They will also convert back to gallons when US units are selected.

WATER TOTALIZER

The Water totalizer can be used for measuring the water usage if a water meter is connected to the Marksman. The Water totalizer is reset by choosing reset on this page (or the website if applicable). The Water totalizer is saved to memory and will not reset on power down.

Water is totalized in either G or L, depending on what is selected on the ADV SETUP WTR page.

The Water totalizer will rollover back to zero at 100,000,000 (Gallons or Liters)

WATER TOTALIZER MODE

There are three settings for totalizing water:

- DSBL Water is not totalized although water rate will still be reported
- MARK Water is only totalized while the Marksman is pumping
- ALWY Water is totalized anytime the meter reports flow

If water is in ALWY mode, the Marksman will continue to record info to update the water total every hour or when water flow drops below 25 GPM when the product pump isn't running.

MENU 3/7

BATCHING



3/7	*BATCHING*
BATCH	ENBL
SPT	123.4 G
TOTAL	200.0 G
RESET	CANCEL
IRRIG KILL	DSBL
PK DLY	2MIN

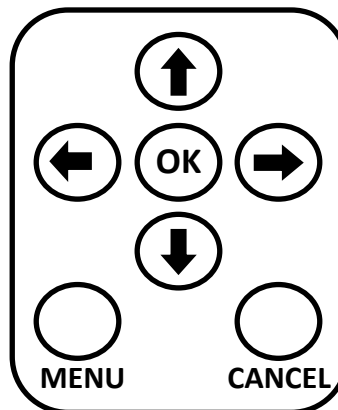

BATCH

This turns on or off the batch function; set to ENBL (Enable) or DSBL (Disable). When enabled, the controller will dispense up to the setpoint and turn off. When disabled, the controller will run at the application rate indefinitely until turned off by some other input (CANCEL button, remote stop input, etc.) **When enabling the batch function also reset the batch totalizer to zero.** The totalizer will not reset to zero the first time batch is enabled. However, when each batch is complete, the totalizer will reset to zero when a run command is given again to start the pump and dispense another batch.

BATCH SPT

The batch setpoint is the amount to dispense in each batch in gallons (or liters if ml/m is the rate unit). When BATCH is disabled, this setting is not used. If BATCH SPT is set to zero and BATCH is enabled, the system will not batch, but pump continuously.

TOTAL

This is a totalizer independent of the Product totalizer on the previous page. The BATCH totalizer will count up until the batch setpoint is reached. When a run command is given again, the batch totalizer will reset and once again dispense the batch setpoint. The Batch totalizer will also keep its value on power down or power loss. If the batch is stopped (manually, power loss, or by another alarm) before it is completed, the batch total will resume where it left off when the pump is started again. If a complete batch is desired in these situations, the batch must be reset using the batch reset on this screen.

If you are NOT using the batch function, this totalizer can be used for information and the BATCH totalizer can be reset by the user on this screen if desired.

IRRIG KILL

The default setting is that the irrigation kill output is not turned on when a batch is completed, but only for alarm conditions. If a irrigation kill is desired at the end of the batch, it can be enabled here. "IRRIG KILL DELAY" will display on the front screen with minutes remaining if active.

IK DLY

The irrigation kill delay determines how long (in minutes) the Marksman will wait before issuing a irrigation kill output on batch completion. This may be useful for flushing the system before shutdown. 0-65535 Minutes

MENU 4/7

SETTINGS 1

F

Setup & Operation

4/7	*SETTINGS 1*	
WATER SPT	DSBL	
SPT	200.0	GPM
REMOTE SPT	DSBL	
MAX	100.0	GPH
MIN	0.0	GPH
OFF	1.0	GPH

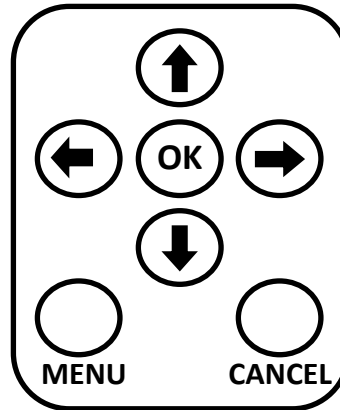

WATER

This turns on or off the water proportional mode with rate control based on water flow rate; set to ENBL (Enable) or DSBL (Disable). An optional water flowmeter must be connected to use this function. Set the water flow meter calibration on ADV SETUP - WTR page.

WATER SPT

The water setpoint is the water volume at which the application rate (RATE on Menu 1/7) will be dispensed. As the water flow increases or decreases from this setpoint the application rate will vary. With a setpoint of 200.0 GPM, when water flow is actually 100 GPM, the application rate will be 50% of the rate shown on menu 1/7. When the water flow is actually 250.0 GPM, the rate will be 125% of the rate shown on menu 1/7.

REMOTE SPT

Remote rate is used for prescription injection. The controller will accept a voltage varying from 0-5 volts. At 5.0 volts, the MAX rate will be applied (100.0 GPH shown above). Also set the ROFF setting on PID SETUP page when using this mode. BATCH mode cannot be used with REMOTE SPT mode.

REMOTE RT MAX

The application rate when signal voltage is 5.0 volts.

REMOTE RT MIN

The application rate when signal voltage is 0.0 volts. SureFire recommends setting this at 0 GPH.

ROFF

This setting is used with prescription control for remote rate. Any incoming signal lower than ROFF setting will turn off the Marksman pump.

NOTE: RATE on menu 1/7 will show the calculated rate based on input voltage when REMOTE RT is enabled. However, you will have to leave menu 1/7 and come back to the page to see the RATE update based on a voltage change.

MENU 5/7

SETTINGS 2



5/7	*SETTINGS 2*
FIELD #	1
PIVOT FT	1300
FEET/MIN	2.5
LOG INT	10 MIN
WTR INT	60 MIN
START DLY	0 MIN
13:03	01/08/18

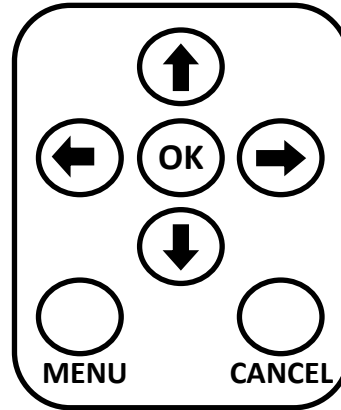

FIELD

Field # is user settable to identify what field the chemical or fertilizer application is being made on. This will be recorded in the USB log file and transmitted to the website if equipped with remote access.

PIVOT FT

The pivot feet setting is only needed if using the gallons or ounces per acre units (Menu 1/7). If using those per acre units, the controller will calculate the area covered and apply the correct rate per acre.

FEET / MIN

The speed of the end of the pivot in feet per minute needs to be entered to apply in per acre units also. The most accurate way to get this number is to actually measure how far the end of the pivot moves and time that movement for 2 -3 cycles of the end tower moving.

NOTE: Pivots with corner swing arm can use both the per acre application units and the proportional water control. The pivot feet will be set to the length for the standard pivot less swing arm. The pivot speed will be the speed at that point (less swing arm). Then, when the swing arm is engaged, the water flow increases. The controller will detect this increased water flow and increase the water rate proportionally. The end result is accurate application over the entire watered area.

LOG INT

The controller can keep a log of application info on a USB drive and send the same data to the SurePoint website if equipped with a modem. The log function is turned off if set to zero. SurePoint recommends setting an interval between 3 - 30 minutes. If equipped with remote access, the controller will send data to the website. The default setting is 10 minutes and additional data charges may apply if set to less than 10 minutes.

WTR INT

When the controller is in Water Totalizer mode of 'ALWY' and the Marksman is not pumping product, data will still be logged at this interval to record water totals. Default is 60 minutes. If set to zero, data is not logged if Marksman is not pumping product.

START DLY

The controller can delay 0-99 minutes after a start command is received before running. "DELAYING START" will display on the front screen with seconds remaining. If a stop command is received during the delay, the count is reset and the start command is canceled. Set to 0 if no delay is desired.

TIME AND DATE

Date and Time displayed here (see Advanced Menu to set time). If using the remote connectivity modem, the time can be auto set via the cellular network.

MENU 6/7 SCHEDULED START/STOP

F

Setup &
Operation

6/7	*SCHED ST/SP*
STRT MODE	DSBL
HOUR	8
MIN	15
STP MODE	DSBL
HOUR	20
MIN	59

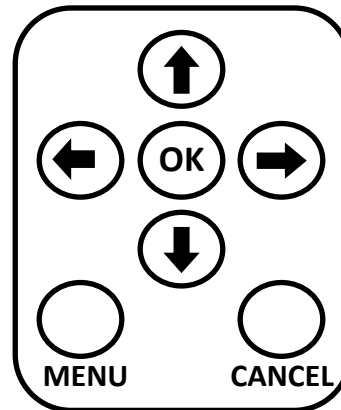

SCHEDULED STRT/STP MODE

The Marksman has a scheduled start and stop feature which has three modes:

DSBL No scheduled start or stop

ONCE The scheduled start or stop will occur once. After the event is triggered, the mode will change to DSBL.

REP The scheduled start or stop will repeat whenever the trigger time is encountered.

STRT/STP HOUR/MIN

This is the scheduled time that the start or stop will occur. This time is specified in 24 hour format (8 PM = 20, 12 AM=0). To prevent the user from inadvertently causing a start or stop event while setting the scheduled time, the mode will be placed in DSBL automatically whenever the time is adjusted. After the time is set, the user must then select the mode (ONCE or REP).

If a ONCE start or stop is set, but the unit is already in the desired run state when the scheduled time is crossed, the mode will still be changed to DSBL. The one time start or stop command will be “used up” any time the scheduled time is past.

BATCH MODE AND SCHEDULED STRT/STP

Batch mode can be used with scheduled start / stop. You could set a scheduled start time and enable batch mode. Marksman will start at the scheduled time and dispense the batch amount. You could use a ONCE start do just do this one time, or a REP start to dispense the batch amount every day at the set time. A scheduled stop time would not be used in this case.

Batch mode can be used with a scheduled stop. If the batch completes before the scheduled stop occurs, the Marksman will stop. If the scheduled stop occurs before the batch is complete, Marksman will stop. However, the next time Marksman starts it will finish the remainder of the batch.

EXAMPLE 1

At 8:15 AM, a user sets a ONCE start time of 8 AM and a ONCE stop time of 8 PM (20:00). The Marksman will issue a stop that evening and will start again at 8 AM the next morning and keep running.

EXAMPLE 2

At 1 PM (13:00), a user sets a REP start time of 7 PM (19:00) and a ONCE stop time of 10 AM. The Marksman will start up that evening and run until 10 the next morning. Because REP was selected for the start, the Marksman will start again that next evening and keep running.

**Timed Start/Stop is ignored when Remote Setpoint is enabled.

MENU 7/7

AUX INFO

F

Setup &
Operation

```
7/7 * AUX INFO *
TNK LVL 1983.5 G
TNK ALM 100.0 G

AUX DIG INPUT: 1
AUX DI INV: DSBL
AUX PRESS: 1000
AUX P CAL: 1500
```

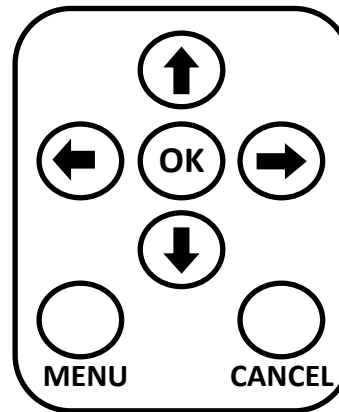

TNK LVL

This is a tank level estimate based off of starting value and usage recorded by the flow meter. It is essentially a totalizer that counts down to zero. If using the mL/M (Milliliters per minute) units for rate setpoint, the tank level will be in liters. This value automatically converts G<->L when the rate unit is changed. When the tank is filled or at a known value, the current level can be edited by the user. This value can be edited while running. 6553.5 G or L is the maximum value.

TNK ALM

Once tank level is at or below this value, an alarm is shown on the front screen. This will not shut down the Marksman, it is a visual alarm only. Setting this value to 0 disables the alarm.

AUX DIG INPUT

This shows the state (1 or 0) of the auxiliary digital input. This input is called **FLOAT** on the Aux Adapter harness. When a connection is made between the two wires of the connector, the state changes to 1. This input can be inverted with the AUX DI INV setting below. If it is desired to have this input stop and alarm the Marksman, contact SureFire. Advanced settings will need to be changed. The system will then be in alarm when the state shows '1'.

AUX DI INV

When enabled, this setting inverts the state of the auxiliary digital input.

AUX PRESS

This displays the current value of the auxiliary pressure. This input is called **AUX PRESS** on the Aux Adapter harness. It can be used to display the value of any 0-5VDC signal and is scaled depending on the value of AUX P CAL.

AUX P CAL

This is the calibration number for the AUX PRESS reading. AUX PRESS will read 0 at 0VDC. Set this number to what value is to be displayed when incoming voltage is at 5VDC. Readings in between will be scaled linearly. 65535 is the max value.

ADVANCED MENU - ADV SETUP-ALM

F

Setup &
Operation

```
ADV SETUP - ALM
NOT AT RATE ALM
DEADBND 15.0%
TIME 300 SEC
NO FLOW TIME
        60 SEC
ALM NUM 0
ALM ENBL 20351
```

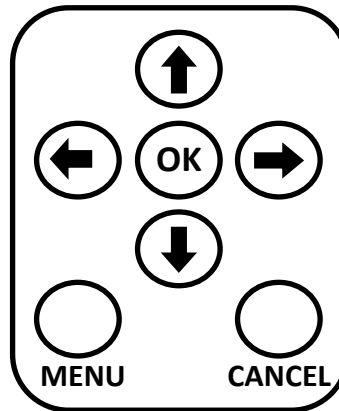

NOT AT RATE ALM

This alarm sets the percent off rate when the unit will shut down. As shown here, the unit will have to be 15% above or below the set rate amount for 300 seconds (5 minutes). If these conditions are met the unit will shut down automatically. You can increase or decrease the **DEADBAND** and **TIME** settings. Deadband can be set from 15-100% and Time can be set from 10-65535 sec.

NO FLOW TIME

If the chemical flow goes to zero, the unit will shut down after this many seconds. As shown on the screen, the unit would shut down after 60 seconds at zero flow. Time can be set from 10-65535 sec.

No Flow Time also will apply to the water flow if water proportional control is enabled.

ALM NUM

Alarm number shows which alarms are currently in alarm state. Consult with SurePoint to interpret this number if necessary.

ALM ENBL

This number determines which alarms are allowed to shut down operation. Consult with SurePoint to interpret this number if necessary.

ADVANCED MENU - ADV SETUP-CHM

F

Setup &
Operation

ADV SETUP	-	CHM
PRES HI	200	PSI
HI DLY	0	SEC
PRES LO	0	PSI
LO DLY	2	SEC
PULSES/G	22710	
PRESS CAL	400	PSI
CONTROL		PWM

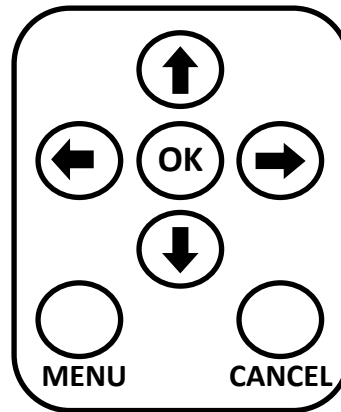

PRES HI

This is a high pressure shutdown point for the chemical / fertilizer being pumped. The pump will be turned off when this pressure is reached. High pressure shutdown is disabled when set to the PRES CAL value.

HI DLY

High Delay is the number of seconds the high pressure condition must be met before shutdown. If the pressure drops below the high setpoint, the timer is reset. 0-255 Sec

PRES LO

This is a low pressure shutdown point for the chemical / fertilizer being pumped. The pump will be turned off when this pressure is reached. Low pressure shutdown is disabled when set to zero. The low pressure alarm is ignored for 2 minutes after the pump starts to give the system pressure time to stabilize. *Note: By setting a low pressure shutdown point, Marksman may be able to shutdown if a hose breaks, provided that a broken hose causes pressure to drop below the set value.*

LO DLY

Low Delay is the number of seconds the low pressure condition must be met before shutdown. If the pressure rises above low setpoint, the timer is reset. 0-255 Sec. When the Marksman is first started, the controller waits 2 minutes to start checking for low pressure. If the low delay is set for 10 sec, the Marksman will alarm if the pressure is low for 10 seconds after the initial 2 minute starting period.

PULSES G

This is the pulses per gallon from the chemical / fertilizer flowmeter (pulses / L if unit selected).

- 22710 pulses per gallon for the SureFire Polypropylene 0.08 - 3.0 GPM flowmeter typically used on Marksman.
- 3000 pulses per gallon for the SureFire 0.13—2.6 GPM flowmeter used on higher rate Marksman or units manufactured prior to 2019.

Readjusting Flow Cal (Pulses per Gallon) after Catch Test

Formula: (Controller Gallons X Controller Flow Cal)/Actual Gallons Caught = New Flow Meter Cal

Example: (1 Gal Batch X 22710 Flow Cal)/.93 Gal Caught = 24419 New Flow Cal

PRES CAL

The controller uses a 0-5 volt pressure transducer. PRES CAL is the full range value of the pressure transducer. This is the pressure at which a 5.0 volt signal happens. Set to **400** for the standard Marksman pressure sensor.

CONTROL

Set to **4-20** for **AC VFD** Marksman systems. Set to **PWM** to control a **12 VDC pump** with an electric pump driver (EPD).

ADVANCED MENU - ADV SETUP-WTR

F

Setup &
Operation

ADV SETUP	-	WTR
PRES HI	250	PSI
HI DLY	1	SEC
PRES LO	0	PSI
LO DLY	2	SEC
UNITS		G
PULSES/G	22710	
PRESS CAL	400	PSI

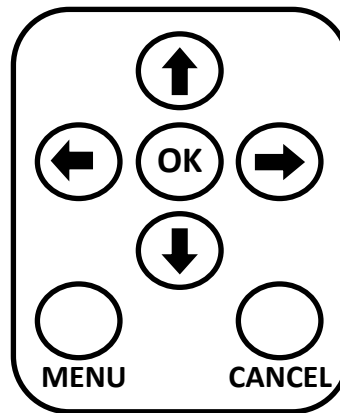

All items on this page are optional and are for the irrigation water being applied. If you are using the Water Proportional Control (Menu SETTINGS 1) the water flow must be connected and a flow calibration entered for the water flowmeter.

PRES HI

This is a high pressure shutdown point for water. The chemical / fertilizer pump will be turned off when this pressure is reached. High pressure shutdown is disabled when set to the PRES CAL value.

HI DLY

High Delay is the number of seconds the high pressure condition must be met before shutdown. If the pressure drops below the high setpoint, the timer is reset. 0-255 Sec

PRES LO

This is a low pressure shutdown point for water. The chemical / fertilizer pump will be turned off when this pressure is reached. Low pressure shutdown is disabled when set to zero. The low pressure alarm is ignored for 2 minutes after the pump starts to give the system pressure time to stabilize.

LO DLY

Low Delay is the number of seconds the low pressure condition must be met before shutdown. If the pressure rises above low setpoint, the timer is reset. 0-255 Sec. When the Marksman is first started, the controller waits 2 minutes to start checking for low pressure. If the low delay is set for 10 sec, the Marksman will alarm if the pressure is low for 10 seconds after the initial 2 minute starting period.

UNITS

This determines whether to use G or L for water total and flow rate.

PULSES/G

This is the pulses per gallon from the water flowmeter (pulses / L if unit selected).

PRES CAL

The controller uses a 0-5 volt pressure transducer. PRES CAL is the full range value of the pressure transducer. This is the pressure at which a 5.0 volt signal happens. Set to 400 for the standard Marksman pressure sensor.

See Marksman accessory items in this manual for pressure sensor and extension cables to connect to the Marksman.

ADVANCED MENU - ADV - SETCLOCK

FSetup &
Operation

ADV - SETCLOCK	
HOUR	13
MINUTE	24
MONTH	9
DAY	20
YEAR	18

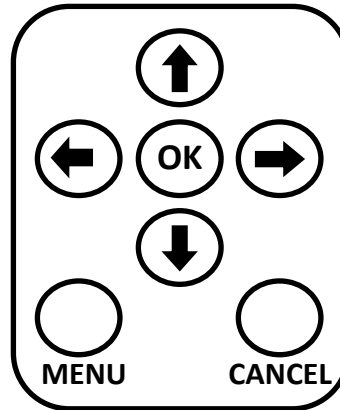
**HOUR**

Enter hour in 24 hour format.

MINUTE

Enter minutes.

MONTH

Enter month

DAY

Enter day of the month

YEAR

Enter the last two digits of the year.

If the Marksman is equipped with remote access, the time can be automatically set from the time received via the cellular network. This feature can be disabled (on CELL DIAG menu) and the time set manually. This may be desirable if you are near a time zone change and the cellular network may pick up a tower in the adjacent time zone.

ADVANCED MENU - DIAGNOST 1

F

Setup &
Operation

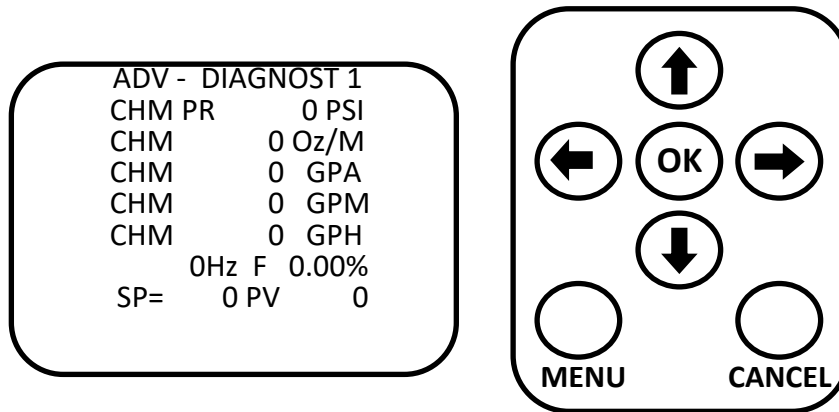

CHM PR

Displays chemical pressure in PSI.

CHM (1-4)

CHM on the Diagnostics screen displays the calculated flow or application rate in multiple units. These values report raw flowmeter feedback and can be used for diagnosing any performance issues. These values have no averaging so they will always fluctuate and never lock on to the application rate.

FLOWMETER FEEDBACK IN Hz

This reports the pulses per second received from the flowmeter.

Forward/Reverse

F or R will appear to indicate motor direction, only meaningful in servo valve operation.

4-20mA or PWM OPERATING PERCENTAGE

This displays the current 4-20mA or PWM percentage the pump is being commanded to run at. For 4-20mA, 0%=4mA and 100%=20mA.

SP & PV

These are internal control values that may be used for troubleshooting. SP is based on the rate setpoint. The controller is continually adjusting to make PV equal to SP.

ADVANCED MENU - DIAGNOST 2

F

Setup &
Operation

```
ADV - DIAGNOST 2
MODE      AUTO
MANUAL%   50.00%
LAST STOP #: 0
CPU RST   130
RESTARTS: 0
RATE:     0.0GPH
LOG:      0.0GPH
```

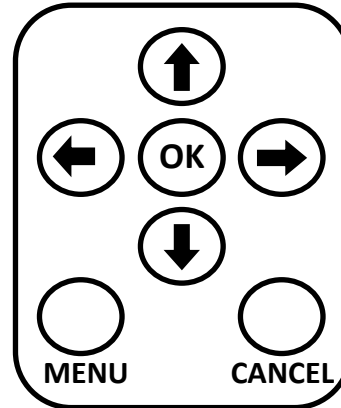

MODE

The mode of operation is either AUTO or MANUAL. Manual allows you to set the PWM or 4-20mA percentage directly. Manual is only used for troubleshooting. Always set to AUTO for normal operation.

MANUAL%

If the mode is set to manual, then the controller will start the pump at this percentage. This field is meaningless for normal operation in AUTO mode. Manual mode will not operate slower than Min PWM setting (Advanced Menu - PID). For example, you can set MANUAL to 10%. However, if MIN PWM (Advanced Menu - PID) is set to 20%, the controller will operate at 20%.

LAST STOP

This displays the last reason the pump was turned off. This information is sent to the website to aid in remotely diagnosing why a unit has shut down. The list of stop reasons is shown below

- 0=No Stop (the only time it will show 0 is after startup)
- 1=Stop 1 (connected to Pivot Stop Input in standard wiring harness)
- 2=Stop 2 (not used in standard wiring harness)
- 4=Water Pressure High
- 5=Water Press Low
- 6=Chem Press High
- 7=Chem Press Low
- 8=USB Error
- 9=No Chem Flow
- 10=Chem Off Rate SP
- 11=No Water Flow (only active in Water Proportional Control mode)
- 12=Power Loss (message created via battery backup)
- 13=Aux Input (when enabled in advanced alarm settings)
- 14=Batch Done Pvt Kill
- 15=Memory Error (Memory was set to defaults due to an error)
- 32=Remote Stop (through website)
- 33=Controller Push button (cancel)
- 34=Batching Operation completed
- 35=Remote STP Mode Turned Off (signal below ROFF setting, see Advanced Menu PID)
- 36=Scheduled Stop

CPU RST / RESTARTS

CPU RST is for processor troubleshooting and RESTARTS will increment every time the processor turns on.

RATE

This is exactly the same rate displayed on the HOME screen. It is shown here to aid in troubleshooting without exiting the advanced menus.

LOG

This rate is sent to the website and the log file. The LOG rate is a longer duration average to aid in remote monitoring.

ADVANCED MENU - DIAGNOST 3

F

Setup &
Operation

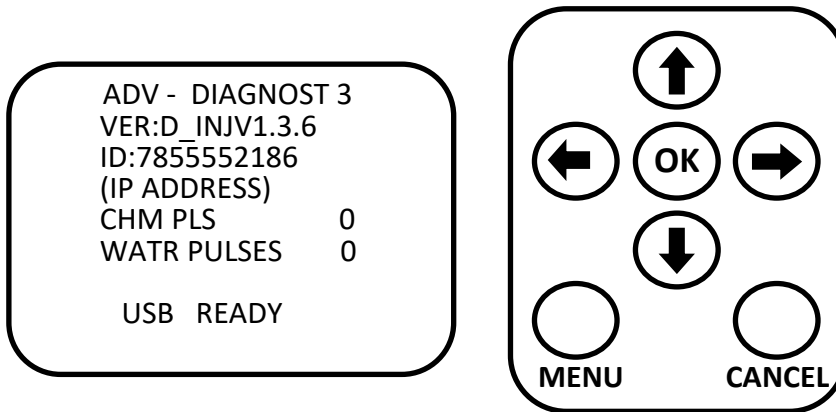

VER

This shows the software version installed on the controller.

ID

The ID will be the phone number of the cellular modem if present.

IP ADDRESS

Displays the current IP address for the modem.

CHM PLS

This rolling counter shows the controller is receiving pulses from the chemical flowmeter. (0-255)

WATR PULSES

This rolling counter shows the controller is receiving pulses from the optional water flowmeter. (0-255)

USB STATUS

'USB READY' or 'INSERT USB' will display here depending on USB flash drive status.

ADVANCED MENU - PID

F

Setup &
Operation

ADV SETUP	-	PID
SAMPLES		50
INTERVAL		0.3
OUT GAIN		7
DEADBAND		10.0%
MIN PWM		3.00%
MAX PWM		100.0%
SOFTSTART		0.0S

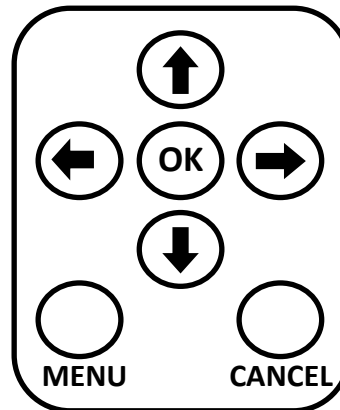

This screen will be used to adjust the control algorithm. If the unit is slow to respond, unstable, or otherwise not performing acceptably, these parameters may need adjusted.

SAMPLES

This is the amount of flowmeter pulses that will be used in a rolling average calculation. The default value is 50. To make the unit respond faster, reduce this number. To make the unit more stable (but slower to respond) increase this value.

INTERVAL

This is the time between PWM adjustments. A higher number causes the controller to adjust more slowly. Default value is 0.3 seconds. Recommended range is 0.1—1.0 seconds. If the rate is not stable and the PWM% is moving up and down quickly (likely causing instability) increase this value. You should see the PWM% adjust more slowly.

OUT GAIN

Out gain sets how large of an adjustment the controller can make. Default value is 7. Lower this setting if the controller is not able to lock onto rate. Increase the out gain if the controller needs to adjust faster to get to rate.

DEADBAND

Deadband is the % from target the controller will start making finer adjustments. Default setting is 10%. If the controller will not lock onto rate raise this setting.

MIN PWM

Min PWM is the minimum percentage the controller will command the pump to run at. Default value is 3%.

MAX PWM

Max PWM is the maximum percentage the controller will command the pump to run at. Default value is 100%.

SOFTSTART

The Marksman will ramp the pump up to speed over the soft start time setting. The default is 0 seconds.

Tips for Running at Lower Rates

At lower rates the PID settings may need modified. If the rate stays above the setpoint you may need to lower the MIN PWM. Watch the rate on the Diagnostic 1 Screen, if the rate (and PV) are bouncing down to zero increase the MIN PWM until this does not happen.

If the system is still not stable (typically at rates under 20 GPH) adjusting INTERVAL and DEADBAND are recommended. Increase INTERVAL to 0.4– 1.0. Increase DEADBAND TO 15-25%. These settings will make the controller slower to reach a new rate, but will increase the stability when running a rate under 20 GPH.

ADVANCED MENU - ADV - CELL DIAG

F

Setup &
Operation

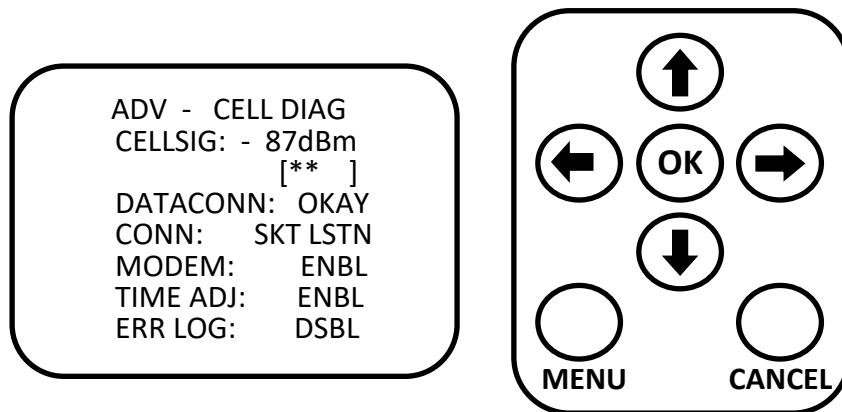

This screen is for the remote access cellular modem if equipped.

CELL SIG

This shows the strength of the cell phone signal. This value will vary from about 70—100. Below it is a cell phone strength graph using “**”. No * means you have no cell phone signal. One * is a weak signal up through a very strong signal of four *.

DATACONN

This displays if the modem is on the data network. Cell signal strength is not always a good indication of data service.

NONE = No Data Signal

OKAY = Data Signal

CONN

This displays the actual status of the cell modem. This should change from SCKT LSTN to SCKT CLSD to SCKT OPEN during normal operation with a good cell signal.

RESETTING = Modem is being initialized and trying to connect to network

NO COMMS = Error communicating with modem

NO PDP = No connection with network, possibly a poor signal

SCKT CLOSED = Connection to server closed

SCKT OPEN = Modem is transferring to or getting information from server

SCKT LSTN = Modem is listening for incoming communication from server

MODEM

This field must be set to ENBL (Enable) if a cell modem is attached. This can be set to DSBL if no modem is attached

TIME ADJ:

Enable this to automatically update the controller date and time with the date and time from the cellular network. If the date/time is more than 2 days off, the date/time will not be updated to prevent a bad date/time from the modem getting set. Set the date manually and the modem should update the time properly. The time adjust feature can be disabled and the time set manually. This may be desirable if you are near a time zone change and the cellular network may pick up a tower in the adjacent time zone.

ERR LOG:

This can be enabled to aid a SurePoint technician if modem problems are occurring. It keeps a log on the USB flash drive of modem errors. This should be disabled unless directed to enable by SurePoint.

ADVANCED MENU- ADV-TEXT ALERT

F

Setup &
Operation

```
ADV - TEXT ALERT
PH1#: 5556260000
PH2#: 5556260001
PH3#: 0000000000

CELL CHIP      SVG
ACCESS TYPE    7
AUTH          SUCCESS
```

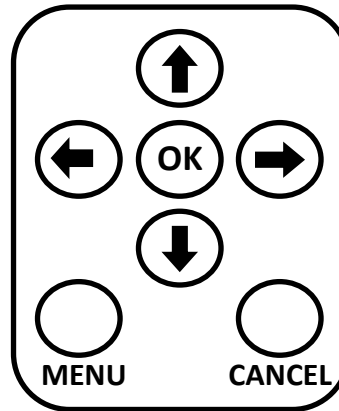

This screen is for setting phone numbers for text alerts

PH 1# - PH#3:

These are the phone numbers that will be sent text messages any time the unit starts or stops. Set the phone number on the controller using the arrow keys to set each digit. The phone numbers to send text messages to can also be changed from the website.

CELL CHIP:

This is for SurePoint to identify what cellular modem is in the Marksman unit.

ACCESS TYPE:

This lets SurePoint know what network the modem is connect to for troubleshooting.

AUTH:

This lets SurePoint know what is going on with the Marksman's server authorization for troubleshooting purposes. In normal conditions, this should cycle between 'ATTEMPT' and "SUCCESS'. Occasionally, the Marksman will need to renew its security token, so 'TOKEN FAIL', 'REF TRY' and 'CREATED' will appear during this process.

(BLANK) = The modem is still initializing, no authorization information is known.

ATTEMPT = Attempting communication with the server that requires security token.

SUCCESS = Successfully transferred data with a security token, existing credentials are good.

CREATED = Successfully obtained new security tokens.

TOKEN FAIL = Communication has failed, the existing token has expired or is invalid.

REF TRY = Attempting to obtain a new security token with an existing refresh token.

REF FAIL = The existing refresh token is invalid, should attempt 'LOGIN TRY'

LOGIN TRY = Attempting to obtain tokens with username and password.

LOGIN FAIL = Username and password are incorrect, may require loading login information via USB

LOGIN SVD = A login.txt file has been loaded.

ADVANCED MENU - ADV - BATT DIAG

F

Setup &
Operation

ADV - BATT DIAG
BATT VOLTS: 12.5
BATT MODE: 4
LAST CHG: 5MIN
PD VOLTS: 12.0

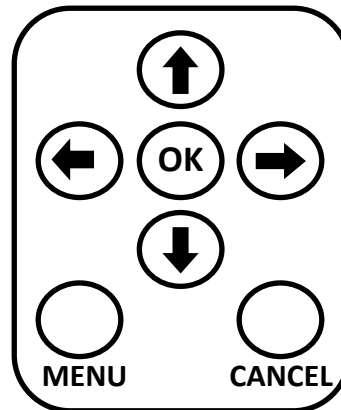

This screen is for battery information

BATT VOLTS

This is the voltage of the 12 VDC backup battery which is checked periodically

BATT MODE

The mode is what state the battery is currently in.

- 0=Currently checking battery voltage
- 1=Voltage sample taken
- 2=Battery is completely dead or a short is detected, charging will not occur.
- 3=Battery is very low and charging
- 4=Battery is OK and charging
- 5=Battery is full charged, not charging
- 6=Power loss detected, running off battery backup
- 7=Error

LAST CHG

This will display how long in minutes it took to recharge the battery to full voltage. It updates when the battery is fully charged.

PD VOLTS

This shows the voltage during the last power loss incident, while the controller was running off of battery backup. If this drops below 10, issues could start to develop during power loss incidents.

BATTERY BACKUP FUNCTION

The Marksman has battery backup to accomplish two functions.

1. Close the Marksman product valve. This prevents any chemical flow through the Marksman into the irrigation system or any irrigation water flow back into the chemical tank. Use of check valves and other regulations must still be met, but the valve closing provides an additional safeguard all flow will be stopped when power is lost.
2. Power the modem for notification of Power Loss failure via text message and website data upload.

Immediately when power is lost the Marksman will initiate shut down and complete the 2 items listed above. When the modem has successfully completed notification the controller will shut down. This could take up to 1 minute.

Error Messages & Troubleshooting

G

Trouble-
shooting

The Marksman controller has several alarms which will stop the pump. This is a list of these error messages and troubleshooting steps for each. These error messages are displayed on the top of the front screen.

Controller Message	Website Alarm & Stop Reason	Description and Troubleshooting Steps
NO CHEM FLOW	No Chemical Flow	<p>The controller is not receiving pulses from the chemical flowmeter. Either the flow has gone to zero or the flowmeter pulses are not being received by the controller. The time to receive this error is set on the ADV SETUP - ALM page under NO FLOW TIME. The default is 60 seconds to shut off with no flow detected.</p> <ol style="list-style-type: none"> 1. Check for empty tanks, closed valves, plugged strainers or other flow obstructions. 2. Verify if flow is present by taking the hose off the injection point or opening bleeder valve. Push OK to start pump and see if product is actually being pumped. 3. If product is not being pumped verify if pump is running (feel if it is vibrating if you can't hear it due to noisy environment). If pump will not run see EPD troubleshooting. 4. If product is being pumped check flowmeter connector and wiring for damage.
OFF RATE STP	Off Rate Setpoint	<p>The flow is too far off the set rate and has stopped the pump. The time and percent off rate to receive this error is set on the ADV SETUP - ALM page under DEADBAND and TIME. The default is 15% off rate for 300 seconds.</p> <ol style="list-style-type: none"> 1. Is the rate set higher than the pump can achieve? If so, reduce rate or possibly reduce pressure so pump can achieve a higher flow rate. Check for partial blockages such as a plugged strainer. 2. Is the rate set lower than the pump can achieve? If so increase the rate. You may be able to run the pump slower by reducing the MIN PWM on PID SETUP page. Raise MIN PWM until the display will never read zero flow with pump on. 3. Is the pump close enough to rate and you want it to continue to run? If so, increase the DEADBAND on the ALM page. 4. Is the pump oscillating around the rate? If so, check for fluid obstructions such as a blocked strainer. See page PID setup; increase INTERVAL, reduce OUTGAIN and/or increase DEADBAND.
CHM PRES LO	Chem Press Low	<p>The chemical pressure has dropped below the PRES LO value on ADV SETUP-CHM page. This alarm is disabled for 2 minutes after starting the Marksman to allow stable chemical pressure to be achieved. After 2 minutes of runtime, the pump will stop immediately if the pressure drops below the PRES LO setting.</p> <ol style="list-style-type: none"> 1. Did a hose break or other failure causing pressure to drop? 2. What is your operating pressure at the current or a minimum flow rate? Set PRES LO 10-20 psi below this pressure. 3. To disable the low chemical pressure alarm set PRES LO to 0.
CHM PRES HI	Chem Press High	<p>The chemical pressure has increased above the PRES HI value on ADV SETUP-CHM page.</p> <ol style="list-style-type: none"> 1. What is your operating pressure at the current or a maximum flow rate? Set PRES LO 10-20 psi above this pressure. 2. To disable the high chemical pressure alarm set PRES HI to PRES CAL value.

Error Messages & Troubleshooting

G

Troubleshooting

The Marksman controller has several alarms which will stop the pump. This is a list of these error messages and troubleshooting steps for each.

Controller Message	Website Alarm & Stop Reason	Description and Troubleshooting Steps
WTR PRES LO	Water Press Low	<p>The water pressure has dropped below the PRES LO value on ADV SETUP-WTR page. This alarm is disabled for 2 minutes after starting the Marksman to allow stable water pressure to be achieved. After 2 minutes of runtime, the Marksman will stop immediately if the pressure drops below the PRES LO setting.</p> <ol style="list-style-type: none"> 1. Did a problem occur in the irrigation system causing low water pressure? 2. What is your irrigation water pressure? Set PRES LO 10-20 psi below this pressure. 3. To disable the low water pressure alarm set PRES LO to 0.
WTR PRES HI	Water Press High	<p>The water pressure has increased above the PRES HI value on ADV SETUP-WTR page.</p> <ol style="list-style-type: none"> 1. Did a problem occur in the irrigation system causing high water pressure? 2. What is your irrigation water pressure? Set PRES HI 10-20 psi above this pressure. 3. To disable the high water pressure alarm set PRES HI to PRES CAL value.
NO WATR FLOW	No Water Flow	<p>The no water flow alarm is only active if you have the proportional water control enabled (WATER on menu 3/5). In this mode, the Marksman will shut off if no pulses received from the water flowmeter after the NO FLOW TIME set on ADV SETUP - ALM page (default 60 seconds).</p> <ol style="list-style-type: none"> 1. Did a problem occur and water flow has stopped? 2. Did the water flowmeter wiring connection get unplugged or damaged? 3. Increase the NO FLOW TIME if this alarm is coming on too quickly.
USB ERROR		<p>This alarm means a good USB drive is not detected by the Marksman controller. The Marksman logs data to the USB drive in addition to sending it to the website. This alarm is not a shutdown alarm and is grayed out on the website for that reason.</p>
STOP 1	Stop 1	<p>Stop 1 comes on if the Pivot Stopped Input (labeled on the wiring harness) detects continuity (a closed relay).</p>
STOP 2	Stop 2	<p>Stop 2 is not wired in the standard Marksman harness. It comes on if the controller terminal S2 is grounded. Use it by attaching a relay that will close and connect ground to terminal S2.</p>
NO POWER	Power Loss	<p>This alarm will show if power is lost and the unit is running off of battery backup. The Marksman controller will send out status info and then shut down.</p>
AUX INPUT	Auxillary Input	<p>This alarm means that the auxiliary input is in a state that has triggered a stop. This alarm is by default not a shutdown alarm and is grayed out on the website. To enable this alarm, advanced settings must be changed, consult SureFire.</p> <ol style="list-style-type: none"> 1. If you aren't using an auxiliary input, contact SureFire to disable the alarm 2. Check status and settings on the AUX INFO page (menu 5/5).

Error Messages & Troubleshooting



The Marksman controller has several alarms which will stop the pump. This is a list of these error messages and troubleshooting steps for each.

Controller Message	Website Alarm & Stop Reason	Description and Troubleshooting Steps
BATCH DONE	Batch Complete (alarm)	Batch mode is enabled and the batch amount has been reached. If Irrig Kill Delay is enabled, "IRRIG KILL DELAY" will display on the main screen and count down the minutes until the irrigation kill output is energized.
MEMORY ERROR	Memory Error	A memory error has occurred and settings may have been returned to factory default. Check all user settings are as desired before restarting. If this happens, notify SurePoint personnel.
	Batch Complete (no alarm)	Batch mode is enabled and the batch amount has been reached. If this isn't the correct function either increase the batch size or disable batch mode (Menu 3/7)
Pump Stops but no error message shown		Go to Advanced Menu - Diagnostic 2. Look at the LAST STOP # and find the reason on the Diagnostic 2 page in this manual. The last stop # will remain there until the OK button is pushed to start the Marksman.

Controller won't turn on



The Marksman can be powered by 12 volts directly, 110 VAC or 480 VAC 3 phase power. If your controller will not turn on follow these steps to find and fix the problem.

1. Make sure that the power toggle switch is in the on (up) position.
2. There is a 3 amp automotive style fuse in the main harness. Check fuse visually or check continuity with a multimeter. If fuse failed, replace with 3 amp fuse.
3. If powering directly from 12 volts, there will be a 40 amp fuse in the power harness near the ring terminals connected to the battery. Check fuse visually or check continuity with a multimeter. If fuse failed, replace with 40 amp fuse.
4. If power from 480 VAC or 110 VAC directly, there is a fuse located in the harness coming out of the 15 volt power supply. Check fuse visually or check continuity with a multimeter. If fuse failed, replace with 40 amp fuse.
5. Check the power coming out of the 110VAC to 15VDC power supply. Disconnect the MP480 connector coming out of the power supply. Use voltmeter to measure voltage coming out of power supply; should be 14-15 volts.
6. If no power out of power supply, measure 110VAC going into power supply with your voltmeter. If using a 110 VAC source, check the source power.
7. If using the SureFire supplied transformer to convert 480VAC 3 phase to 110VAC check the 480VAC source.
8. If you have 480VAC but do not have 110 VAC out of the transformer, check the transformer fuses. The transformer has 3 fuses inside the cover on the bottom of the transformer. Two fuses (1 amp) are on the incoming 480VAC wires. One fuse (4 amp) is on the outgoing 110 VAC wire. See the Components section of this manual for a detailed schematic of the transformer assembly with fuse details.



Turn off power before checking fuses and inspecting 480 VAC 3-phase transformer. Contact a qualified electrician for 480 VAC 3-phase power service.

SurePoint Flowmeter Calibration

Typically, the SurePoint flowmeter measures very accurately with the standard flow calibration setting (3000 or 22710 depending on model). The SurePoint flowmeter will measure with less than 1% error (as low as 0.5%). A catch test needs to be done very carefully to get results that correspond to this level of accuracy.

Catch Test

1. Use accurate measuring containers with significant enough volume to reduce % error. Calibration using larger volumetric containers will result in more accurate field results.
2. Time the test closely. The longer the test runs, the better the accuracy will be.
3. Compare the actual amount caught with the volume indicated by the display.
4. Adjust the flow calibration number as needed.

Increase the flow calibration number if **not enough** product is actually being applied.

Decrease the flow calibration number if **too much** product is actually being applied.

Flow Calibration Adjustment Formula

Formula: (Controller Gallons X Controller Flow Cal)/Actual Gallons Caught = New Flow Meter Cal

Example: (1 Gal Batch X 22710 Flow Cal)/.93 Gal Caught = 24419 New Flow Cal

Electric Pump Won't Run

The Marksman uses an Electric Pump Driver (EPD) to receive the controller signal and control the power required by the 12 VDC electric pump. This is mounted directly above the pump. The Status LED on the EPD provides error codes by the number of times it is flashing.

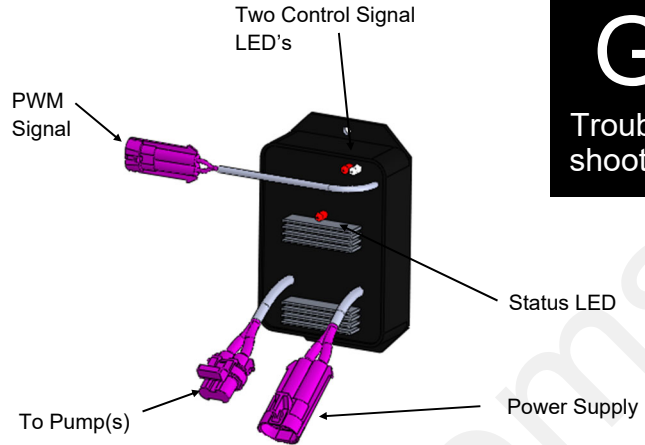

G Trouble- shooting

EPD Status Light

Status LED	Status Description	Troubleshooting Steps
On Steady	Power input is good and PWM input Signal is detected	No Problem. Typical operating condition.
Steady Blink	Power input is good and PWM signal is not detected	Typical 'Off' Condition. If pumps should be on: 1. Inspect wiring and connectors 2. Check voltage at PWM connector to EPD, should be 1-12 volts to turn on.
Blink once, pause, blink once, pause	Open circuit between motor output and motor.	Check harness and connectors to motor. Plug the motor in directly to power by disconnecting Power Supply and pump from EPD and plugging the pump directly into the power supply connector; pump should run 100%
Blink twice, pause, blink twice, pause	Output short circuit detected.	Check harness and connectors to motor.
Three blinks, pause, three blinks, pause	Overcurrent condition	1. Check total load with amp meter. 2. Clean cooling fins on EPD
Four blinks, pause, four blinks, pause	Input power fault. Low voltage condition in power to EPD.	Disconnect EPD power to reset EPD. Inspect connectors for damaged pins, heat damage or any type of poor connection. The poor connection will cause a voltage drop and result in a four flash code. Measure voltage coming into EPD. Next measure voltage into EPD with motor running.
Five blinks, pause	Input frequency out of range.	Contact your dealer or SurePoint Ag Systems for assistance.
Control Signal LEDs		
Light intensity varies	Off - No PWM Signal 100% brightness - Maximum PWM input signal	

Recommended Care and Maintenance

H

Maintenance

Winterization

SureFire recommends flushing your fertilizer pump and complete system with adequate amounts of water first. Next, use RV antifreeze to winterize your system by pumping an adequate amount through all components. At the beginning of the next season, begin with water to verify the system is in working order with no leaks.

Inspect Electric Pumps

The 12 VDC electric pump and motor is a completely sealed component. Over time the electric motor will lose efficiency. The entire pump and motor will need replaced when it won't efficiently produce the flow required.



SurePoint Ag Systems

9904 Hwy 25

Atwood, KS 67730

www.surepointag.com

©2016-2022 SurePoint Ag Systems, Inc.—All Rights Reserved

